

Varenummer: 201580M616MT  
Beskrivelse: E+G Bolt GN 1580-M6-16-MT-H  
Hygiejnisk design

## Mål

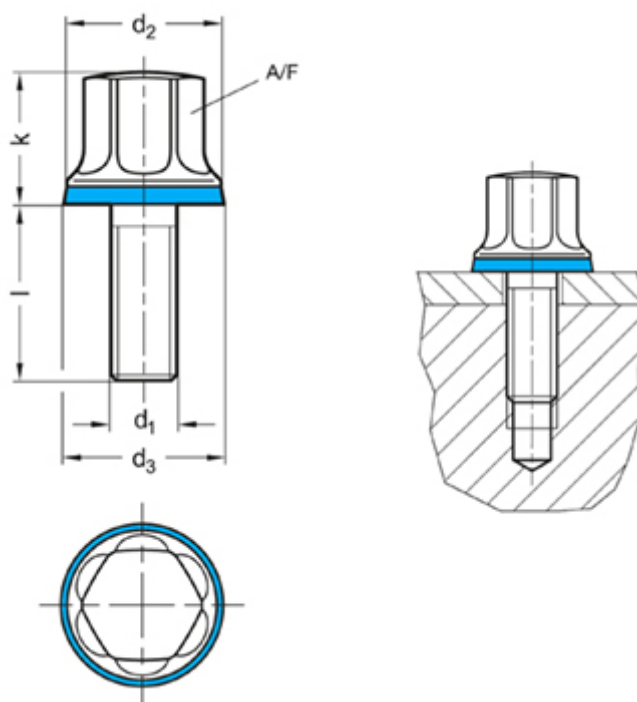

d1	= M 6
d2	= 14
d3	= 14.8
k	= 12
L	= 16
t min	= -
Vægt i (g)	= 12